



**PROSPEC ELECTRONICS**  
prospecelectronics.com | 843.849.9037



## JBL PRV-275 MANUAL

Note! The front of the stereo should be cleaned with a sponge and water. Do not use a pressure washer to clean the faceplate.

## Troubleshooting

\*Note: In many respects, a stereo acts much like a computer and occasionally requires a reboot. In the unlikely event of product malfunction, a reset can usually fix the issue. For software reset operation, please refer to page 7.

Issue	Cause	Solution
No power	<ol style="list-style-type: none"> <li>1. Incorrect wiring</li> <li>2. Fuse is blown</li> <li>3. Low battery voltage</li> </ol>	<ol style="list-style-type: none"> <li>1. Double check wiring</li> <li>2. Replace fuse</li> <li>3. Check voltage of vehicle battery with multimeter. Voltage must be at least 11V.</li> </ol>
No Sound	<ol style="list-style-type: none"> <li>1. Speaker connection came loose</li> <li>2. Bad speaker</li> <li>3. Output blown</li> <li>4. Volume too low on media device</li> </ol>	<ol style="list-style-type: none"> <li>1. Double check connections.</li> <li>2. Replace bad speaker with known good speaker and connect.</li> <li>3. Send unit in for repair.</li> <li>4. Increase volume of media device</li> </ol>
No Reception	<ol style="list-style-type: none"> <li>1. Antenna not firmly seated in socket</li> </ol>	<ol style="list-style-type: none"> <li>1. Insert firmly</li> </ol>
USB stick not reading	<ol style="list-style-type: none"> <li>1. File must be a mp3 or wma file</li> </ol>	<ol style="list-style-type: none"> <li>1. Convert format to mp3 or mwa.</li> </ol>
While in Bluetooth mode:		
No Connection	<ol style="list-style-type: none"> <li>1. You are not connected to the "PRV275" address on your portable media device.</li> <li>2. Out of range</li> <li>3. The connection is already in use.</li> </ol>	<ol style="list-style-type: none"> <li>1. Choose "PRV275"</li> <li>2. Bring portable media device closer to the receiver. Device needs to be within 30'.</li> <li>3. Ask the person who first paired to drop out.</li> </ol>











## Table of Contents

Table of Contents -----	1
Product Description -----	2
Installation Instructions -----	3
Wiring Configuration -----	4
General Function of Buttons -----	5
Sign up Display & Home Menu -----	6
General Settings -----	7
Radio Section Operation -----	9
Bluetooth Section Operation -----	11
USB Section Operation -----	13
AUX Section Operation -----	15
Troubleshooting -----	16

## Product Description

This radio is another forward thinking product from JBL. Other Harman brands include Infinity by Harman, JBL Professional, AKG, Mark Levinson, Harman Kardon, and Revel. Prospec Electronics is Harman's exclusive distributor to OEM's in the marine, side by side, golf car, and hot tub industries. Our products range from mechless receivers, amplifiers, subwoofers, speakers, and other accessories. Prospec is located in Mount Pleasant, S.C., a stone's throw away from Charleston, S.C. Should you need our expertise, please do not hesitate to give us a call. We're all about the music and this music should resonate from components verified to complement your hard earned off road purchase.

The PRV275 incorporates the following features:

-  AM/FM/WB
-  Bluetooth Audio Streaming with ID tagging
-  USB input and control-for USB drives only
-  Auxiliary input
-  2.75" color TFT screen / Waterproof faceplate
-  50W x 4 amplifier/2 ohm stable
-  Wired remote option
-  U.S., European, and Japan tuning
-  Charging through USB
-  3 pair of RCA output including subwoofer output
-  Video input

## AUX Section Operation

### 1. To Select AUX mode

At Home Screen, turn VOL knob and press to select AUX source. (The foreground pop up icon refers to the source changing.)

Or repeat press SRC button to select the desired source



The use of auxiliary mode allows you to play the portable music device through the headphone jack.

Note: An additional accessory/adaptor must be purchased in order for this to happen. Prospec's part, SEAMINI2 or SEAUSBMINI36 fulfills this option.

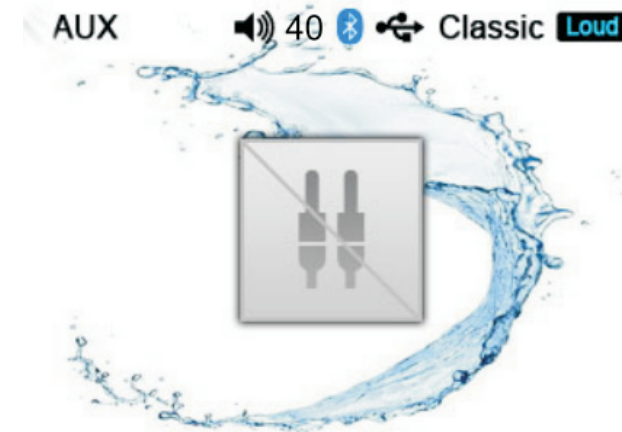

## USB Section Operation

### 4. Track Up/Down

While USB is playing, simply press ►► button to select next track and press ◀◀ button to select the previous track.

To fast forward, press and hold ►► button.

To fast rewind, press and hold ◀◀ button.

### 5. Repeat/ Random/ Scan Play

While USB is playing, repeatedly long press MENU button to switch among Repeat One, Repeat All, or Random play.

Long press MUTE button to switch to Scan play. Long press MUTE again to disable Scan function.

### 6. Track Search

While USB is playing, short press MENU button to enter track search mode, it will display all the tracks in current playing Directory.

- To select other tracks in current directory, just simply turn VOL knob and press the knob at desired track.

- To select the tracks in other directory, press Return button at the track display screen, it will back to directory display, turn VOL knob and press the knob at desired directory, repeat above operation until a track selected.

## Installation

A mounting gasket has been added inside the package for convenience. Trace along the outside edge of the gasket thus revealing your cutout.

### Mounting Illustration

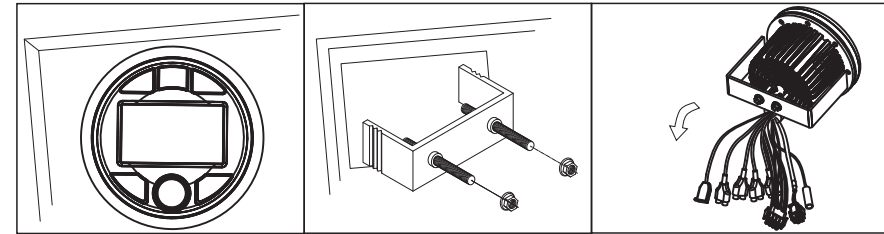

1. Avoid installing stereo below cupholders! Make sure mounting substrate is flat to avoid flexing of the plastic.

2. Use the back bracket and studs to affix the unit. Install the U bracket behind the unit, using two nuts per bolt for ultra hold.

3. To avoid possible water ingress into wire harness area, route the harness in the downward direction as shown above.

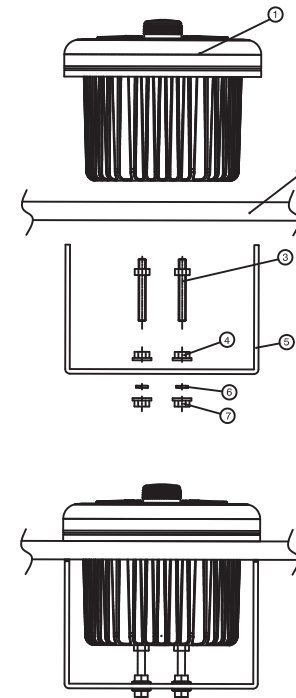

NO.	PART DESCRIPTION
1	RADIO
2	MOUNTING PLATE
3	MOUNTING STUDS
4	JAMB NUTS
5	MOUNTING BRACKET
6	SPRING WASHER
7	OUTER NUTS

#### Instructions:

1. Install jamb nuts (4) loosely on mounting studs (3), so they will not touch mounting brackets (5) when installed.
2. Slip mounting bracket (5) on and make flush with mounting surface (2).  
DO NOT TIGHTEN
3. Snug spring washer (6) and outer nuts (7) against mounting plate (2).  
DO NOT TIGHTEN
4. Position jamb nuts (4) approximately 1/16" from mounting bracket.
5. Tighten outer nuts (7) completely.

## Wire Configuration

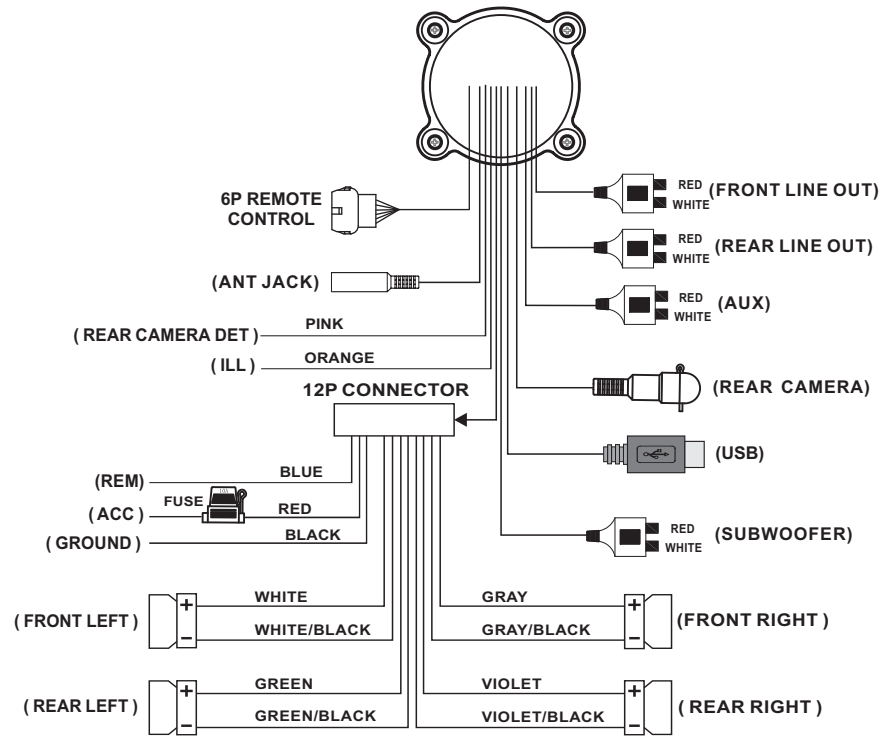

### NOTE:

1. When wiring, the red lead is recommended to be wired to ACC/ignition power lead.
2. Make sure that the black wire on the wiring harness is connected to a good ground point on the boat. If the chassis of the boat is used as a ground point, make sure that the surface is scraped clean of paint before attaching the wire to it. It is recommended to connect the black ground wire directly to negative terminal (-) of the boat battery.
3. Before wiring your system, disconnect your boat battery's positive (+) cable. This helps prevent damage in case of a short.

## USB Section Operation

### 1. To Select USB mode

At Home Screen, turn VOL knob and press it to select USB source. (The bigger pop up icon refers to the source changing.)

Or simply repeat press SRC button to select the desired source.

Note: This input is designed to read and play USB drives (mp3 and wma files), not media.



### 2. USB Screen Description

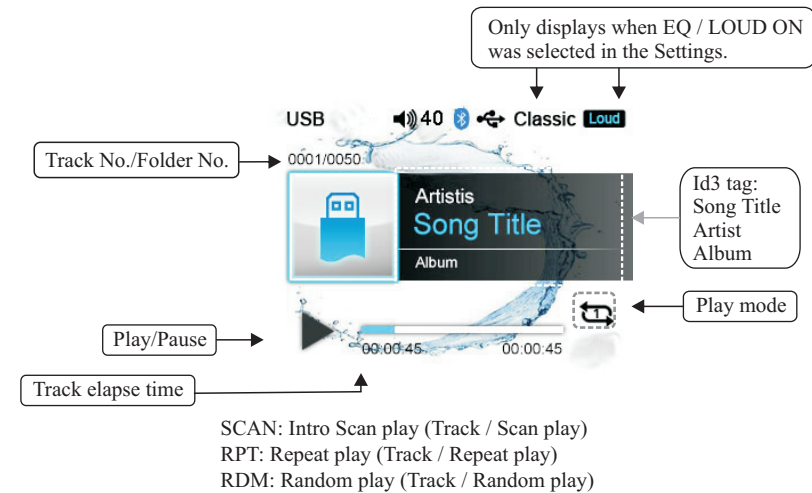

### 3. Play/Pause Play

While USB is playing, press the PAUSE button to pause the playback, and press again to resume playback.

Note: **||** refers to PLAY; **▶** refers to PAUSE.

## Bluetooth Section Operation

### 4. Play/Pause Play

Once the BT device is paired successfully, music will begin to play.

Note: For some Bluetooth enabled phones, you may need to activate play from your phone first. It depends on the phone itself.

While BT Music is playing, press the PAUSE button to pause the playback, and press it again to resume playback.

Note: **||** refers to PLAY; **▶** refers to PAUSE.

### 5. Disconnect / connect

In BT Music playing mode, in order to disconnect the BT device, long press the MENU button. If you want to reestablish the BT connection, long press MENU button in BT source again. Once you power on the unit the next time, it will establish the Bluetooth connection automatically.

Note: When your BT device battery is at low charge, the Bluetooth connection may occasionally be lost. To maintain good connectivity ensure that your BT device battery is adequately charged.

## General Function of Buttons

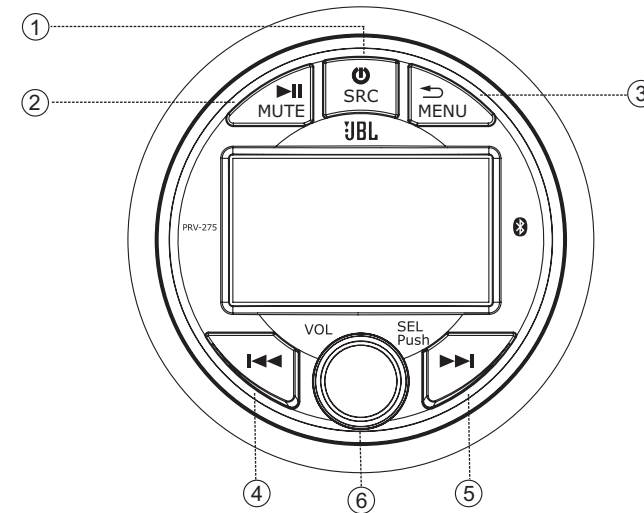

### 1. POWER, SRC button

- With unit off, press to power the unit on.
- With the unit on, press and hold for over 2s to power the unit off.
- Press SRC button to switch modes among FM/ AM/WB/ BT/ USB/ AUX.

### 2. Pause, Mute button

- In Radio (FM/AM/WB), AUX playing mode, press it to MUTE sound output, press it again to resume sound output.
- In BT Music source playing, press it to PAUSE playback, press it again to resume playback.
- In USB source playing, press and hold it for 2s to activate Track Scan. With Track Scan activated, simply press it again to resume normal playback.

### 3. Return, MENU button

- Short press to return to previous screen.
  - Long press to enter menu (sub-function) for each source.
- (See details in each source operation.)

### 4. <<< and >>> button

- In Radio (FM/AM/WB) source playing, short press it to select the previous or next station. A long press results in manual tuning mode.
- In BT Music source playing, short press it to select the previous or next track.
- In USB source playing, Press and hold to go through the tracks fast forward or rewind.

### 6. VOL knob, SEL/ENTER button

- At source playing status, turn the knob to increase or decrease volume level.
- In selection status, turn it to scroll to move highlight upward/ over, and press it to confirm selection.

## Sign Up Display & Home Menu

### 1. Sign up

Once the unit powers on, the introductory home screen appears for 5 seconds, then switches to the last played mode before power off occurred.



### 2. Home Screen (source display)

At Home Screen, turn VOL knob to move to desired source and press ENTER button to enter the desired source.



## Bluetooth Section Operation

### 1. To Select Bluetooth mode

At Home Screen, turn VOL knob and press it to select BT source. (The foreground pop up icon refers to the source changing.)

Or simply repeat press SRC button to select the desired source.



### 2. Bluetooth Screen Description

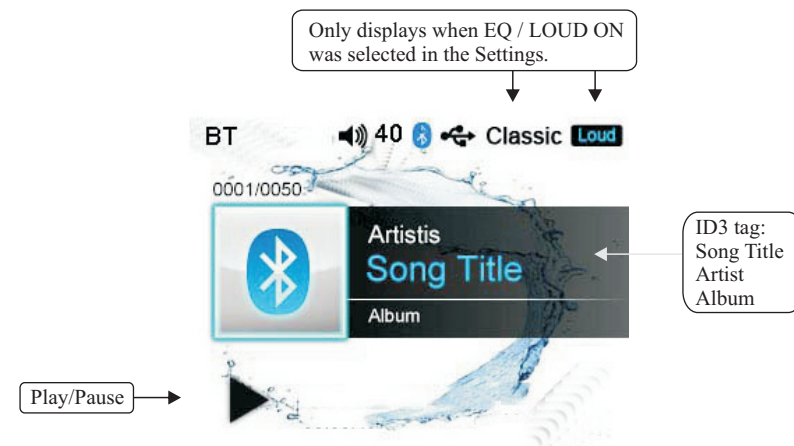

### 3. Pair BT Device

In Bluetooth playing mode, pick "PRV275" option on your Bluetooth enabled device. (if you are prompted for a password, the code entered will be "0000".)



## Radio Section Operation

### 3. Auto Tuning

In AM, FM, WB playing mode, simply press ►► or ◄◄ button to activate auto tune. This results in automatically stopping at next station of sufficient signal strength.

### 4. Manual Tuning

In AM, FM, WB playing mode, long press ►► or ◄◄ button for 2s. This will activate manual tune with MANU display on the top area. Then repeatedly press ►► or ◄◄ button to tune frequency by steps.

NOTE: Radio will revert back to AUTO tune mode after 5s without operation.

### 5. Station Save

In FM, AM, WB play mode, manually or auto tune to a station, then long press MENU button to display Radio sub-menu. Press SEL button when Preset List is highlighted, Turn VOL knob to select a preset No., then press and hold the knob to save current station into that Preset No.. The Preset number will display once the station is saved. The unit will go back to previous display if no operation in 5s.

NOTE:

1. In FM, AM, WB mode, Receiver can store up 18 stations in each mode.
2. If there is no operation at Preset List screen, it will go back to Radio screen by itself after 5s.

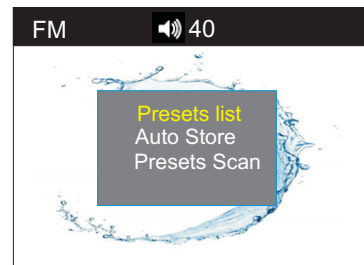

### 6. Auto Store

In AM, FM, WB mode, long press Menu button to display Radio sub-menu. Turn VOL button to move highlight to Auto Store and press the knob to confirm. It will search and store the stations which have strong signal automatically.



### 7. Preset Scan

In AM, FM, WB mode, long press Menu button to display Radio sub-menu. Turn VOL knob to move highlight to Preset Scan and press the knob to confirm. It will scan the preset stations in current source by playing each station for 6s. At desired station, enter sub-menu and select Preset Scan again to stop the preset scanning.

## General Operations

### 1. General Settings

At Home Screen, turn VOL knob and press it to enter Setup, then turn VOL knob to move amongst sub-features. Press the knob at desired feature and turn the knob again to adjust level. Press the knob again to exit current feature adjustment.

Note: If no operation occurs, it will revert back to source playing screen after 5s.



Sub Freq	120Hz
Sub Woofer	16
Brightness	5
Radio Area	USA
Soft Version	
Soft Reset	
MCU Update	
I-Volume	10

#### 1-1. Subwoofer Low Pass Flitter Control

In Settings screen, turn VOL knob and press enter Sub. Freq. (Subwoofer low pass filter) adjustment, turn the knob to select among 80Hz, 120Hz, 160Hz. Press the knob again to exist Sub. Freq. adjustment.

#### 1-2. Subwoofer Volume control

In Settings screen, turn VOL knob and press the knob when it highlights at Subwoofer, then turn the knob to adjust subwoofer volume from 0 to 20. Press the knob again to exit Subwoofer volume control.

#### 1-3. Brightness Control

In Settings screen, turn VOL knob and press the knob when it highlights at Brightness, then turn the knob to adjust Brightness from 0 to 5. Press the knob again to exit Brightness control.

#### 1-4. Radio Area Selection

In Settings screen, turn VOL knob and press the knob when it highlights at Radio Area, then turn the knob to select Area amongst USA, EUR and JAPAN. Press the knob again to exit Radio Area selection.

#### 1-5. Software Version Display

In Settings screen, turn VOL knob and press the knob when it highlights at Soft Version to display the Software Version.

#### 1-6. Software Reset

In Settings screen, turn VOL knob and press the knob when it highlights at Soft Reset; it will reset the settings to default value with display "Software Reset...". Once resetting is finished, it will revert back to settings screen by itself.

Note: All the settings, including audio settings, system settings, preset stations would be cleared with Soft Reset carried out.

#### 1-7. MCU Update

The PRV275 supports software updates via USB.





## General Settings

### 1-8. I-Volume Control

In Settings screen, turn VOL knob and press the knob when it highlights at I-Volume. Then turn the knob to adjust I-VOL from 0 to 40. Press the knob again to exit I-Volume control.  
Note: The I-Volume determines the volume level when the unit is powered on.

### 1-9. Rear Camera Control

With Rear Camera connected, once triggered, it will change to Camera display. You can select Camera OFF in Settings.

In Settings screen, turn VOL knob and press the knob when it highlights at Camera. Then turn the knob to select Camera ON or OFF. Press the knob again to exit Camera control.

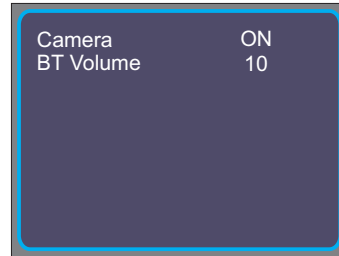

### 1-10. BT I-Volume Control

In Settings screen, turn VOL knob and press the knob when it highlights at BT Volume. Then turn the knob to adjust BT Volume from 0 to 40. Press the knob again to exit BT Volume control.

Note: The BT Volume determines the volume level of BT Music playing when powered on.

## 2. Audio Settings

In any source playing status, press SEL button to enter Audio Settings. Then repeat press the knob to display as following sequence:

BAS --> MID --> TRE --> BAL --> FAD --> EQ --> LOUD --> BEEP.

At each setting, turn the knob to adjust the level. The waiting time for adjustment is 5s.

- BAS. Turn VOL knob to adjust Bass level from -7 to +7.
- MID. Turn VOL knob to adjust Middle level from -7 to +7.
- TRE. Turn VOL knob to adjust Treble level from -7 to +7.
- BAL. Turn VOL knob to adjust Balance level from L12 to R12.
- FAD. Turn VOL knob to adjust Fader level from F12 to R12.
- EQ. Choose among Flat, Classic, Pop, Rock or OFF.
- LOUD. Choose between Loud ON or OFF.
- Beep. Choose among Beep 2ND, Beep OFF or Beep ON.

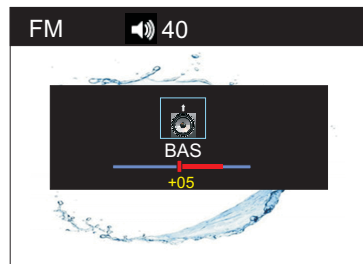

## Radio Section Operation

### 1. To Select Radio mode

At Home Screen, turn VOL knob and press it to select AM, FM or WB source. (The bigger pop up icon refers to the source changing.)

Or simply repeat press SRC button to select the desired source.



### 2. Radio Screen Description

