



EON ONE PRO

ALL-IN-ONE RECHARGEABLE PA

USER'S GUIDE





For: Français, Deutsch, Español, visit www.jblpro.com

Contents

Section 1: Important Safety Instructions	1
Care & Cleaning.....	2
Section 2: Precautions.....	3
Section 3: EON ONE PRO System Declaration of Conformity	4
Section 4: Introduction to the EON ONE PRO System	5
Getting Started.....	5
PA Basics	8
Getting Acquainted with the EON ONE PRO Powered Mixer.....	8
Audio Inputs	9
Mono Mic/Line Inputs.....	9
Phantom Power Disclaimer.....	10
Stereo Inputs.....	11
Bluetooth Input.....	11
Audio Outputs	12
USB Power Port.....	12
Section 5: Accessories	13
Wheeled Bag	13
Section 6: System Specifications	14
Section 7: Cables & Connectors	15
Section 8: Contact Information	16
Section 9: Warranty Information	17

Section 1: Important Safety Instructions

1. Read these instructions.
2. Keep these instructions.
3. Heed all warnings.
4. Follow all instructions.
5. Do not use this apparatus near water.
6. Clean only with dry cloth.
7. Do not block any ventilation openings. Install in accordance with the manufacturer's instructions.
8. Do not install near any heat sources such as radiators, heat registers, stoves, or other apparatus (including amplifiers) that produce heat.
9. Do not defeat the safety purpose of the polarized or grounding-type plug. A polarized plug has two blades with one wider than the other. A grounding-type plug has two blades and a third grounding prong. The wide blade or the third prong is provided for your safety. If the provided plug does not fit into your outlet, consult an electrician for replacement of the obsolete outlet.
10. Protect the power cord from being walked on or pinched, particularly at plugs, convenience receptacles, and the point where they exit from the apparatus.
11. Only use attachments/accessories specified by the manufacturer.
12.  Use only with the cart, stand, tripod, bracket, or table specified by the manufacturer, or sold with the apparatus. When a cart is used, use caution when moving the cart/apparatus combination to avoid injury from tip-over.
13. Unplug this apparatus during lightning storms or when unused for long periods of time.
14. Refer all servicing to qualified service personnel. Servicing is required when the apparatus has been damaged in any way, such as power supply cord or plug is damaged, liquid has been spilled or objects have fallen into the apparatus, the apparatus has been exposed to rain or moisture, does not operate normally, or has been dropped.
15. Service Instruction in Owner's Manual: "CAUTION: THESE SERVICING INSTRUCTIONS ARE FOR USE BY QUALIFIED SERVICE PERSONNEL ONLY. TO REDUCE THE RISK OF ELECTRIC SHOCK DO NOT PERFORM ANY SERVICING OTHER THAN THAT CONTAINED IN THE OPERATING INSTRUCTIONS UNLESS YOU ARE QUALIFIED TO DO SO."
16. **CAUTION: DANGER OF EXPLOSION IF BATTERY IS INCORRECTLY REPLACED. REPLACE ONLY WITH THE SAME OR EQUIVALENT TYPE.**
17. **WARNING: DO NOT EXPOSE BATTERIES OR BATTERY PACK TO EXCESSIVE HEAT, SUCH AS THAT FROM OPEN FLAMES, DIRECT SUNSHINE, ETC.**
18. To completely disconnect this apparatus from the AC mains, disconnect the power supply cord plug from the AC receptacle.
19. "WARNING: TO REDUCE THE RISK OF FIRE OR ELECTRIC SHOCK, DO NOT EXPOSE THIS APPARATUS TO RAIN OR MOISTURE."
20. Do not expose this equipment to dripping or splashing and ensure that no objects filled with liquids, such as vases, are placed on the equipment.
21. WARNING: The mains plug/appliance coupler is used as disconnect device, the disconnect device shall remain readily operable.
22.  Protective earthing terminal. The apparatus should be connected to a mains socket outlet with a protective earthing connection.
23.  Correct Disposal of this product. This marking indicates that this product should not be disposed with other household wastes throughout the EU. To prevent possible harm to the environment or human health from uncontrolled waste disposal, recycle it responsibly to promote the sustainable reuse of material resources. To return your used device, please use the return and collection systems or contact the retailer where the product was purchased. They can take this product for environmental safe recycling.
24. No naked flame sources, such as lighted candles, should be placed on the apparatus.
25. For adequate ventilation, do not install this equipment in a confined or enclosed space, such as a book case or similar unit. Product ventilation should not be impeded by covering the ventilation openings with items such as newspaper, tablecloths, curtains, etcetera.

CARE & CLEANING

EON ONE PRO systems may be cleaned with a dry cloth. Do not get moisture into any of the openings in the system. Ensure that the system is unplugged from the AC outlet before cleaning.

THIS APPARATUS CONTAINS POTENTIALLY LETHAL VOLTAGES. TO PREVENT ELECTRIC SHOCK OR HAZARD, DO NOT REMOVE CHASSIS, MIXER MODULE, OR AC INPUT COVERS. NO USER SERVICEABLE PARTS INSIDE. REFER SERVICING TO QUALIFIED SERVICE PERSONNEL.

Section 2: Precautions



The EON ONE PRO system covered by this manual is not intended for use in high moisture environments. Moisture can damage the speaker cone and surround and cause corrosion of electrical contacts and metal parts. Avoid exposing the speakers to direct moisture. Keep speakers out of extended or intense direct sunlight. The driver suspension will prematurely dry out and finished surfaces may be degraded by long-term exposure to intense ultra-violet (UV) light. The EON ONE PRO system can generate considerable energy. When placed on a slippery surface such as polished wood or linoleum, the speaker may move due to its acoustical energy output. Precautions should be taken to assure that the speaker does not fall off a stage or table on which it is placed.

Hearing Damage, Prolonged Exposure To Excessive SPL

The EON ONE PRO system is capable of generating sound pressure levels (SPL) sufficient to cause permanent hearing damage to performers, production crew, and audience members. Caution should be taken to avoid prolonged exposure to SPL in excess of 90 dB.

WATCH FOR THESE SYMBOLS!

The exclamation point within an equilateral triangle is intended to alert the user to the presence of important operating and maintenance (servicing) instructions in the literature accompanying the product.

The lightning flash with the arrowhead symbol within an equilateral triangle is intended to alert the user to the presence of un-insulated "Dangerous Voltage" within the products enclosure that may be of sufficient magnitude to constitute a risk of electric shock to persons.



Section 3: EON ONE PRO System Declaration of Conformity

This equipment complies with the EMC directive 89/336/EEC
Modified by
92/31/EEC
93/68/EEC
98/13/EEC and LVD 73/23/EEC modified by 93/68/EEC



This product meets safety standards:
EN60065:2002
UL6500 7th Edition: 2003
UL 60065 - STANDARD FOR AUDIO, VIDEO AND SIMILAR ELECTRONIC
APPARATUS - SAFETY EQUIREMENTS - Edition 7 - Revision Date 2007/12/11
CSA C22.2 NO 60065-03 - AUDIO, VIDEO AND SIMILAR ELECTRONIC
APPARATUS – SAFETY REQUIREMENTS - Edition 1 - Revision Date 2006/04/01
IEC 60065 - AUDIO, VIDEO AND SIMILAR ELECTRONIC APPARATUS -- SAFETY
REQUIREMENTS - Edition 7.1 - Issue Date 2005/12/01

And EMC Standards
EN55103-1 (E2)
EN55103-2 (E2)

This device complies with Industry Canada's licence-exempt RSSs. Operation is subject to the following two conditions:

- (1) This device may not cause interference; and
- (2) This device must accept any interference, including interference that may cause undesired operation of the device.

Le présent appareil est conforme aux CNR d'Industrie Canada applicables aux appareils radio exempts de licence.
L'exploitation est autorisée aux deux conditions suivantes :

- (1) l'appareil ne doit pas produire de brouillage;
- (2) l'utilisateur de l'appareil doit accepter tout brouillage radioélectrique subi, même si le brouillage est susceptible d'en compromettre le fonctionnement.

Changes or modifications not expressly approved by the party responsible for compliance could void the user's authority to operate the equipment.

FCC Compliance Notice

This device complies with part 15 of the FCC rules. Operation is subject to the following two conditions: (1) This device may not cause harmful interference, and (2) this device must accept any interference received, including interference that may cause undesired operation.

CAUTION: Changes or modifications not expressly approved by the party responsible for compliance could void the user's authority to operate the equipment.

NOTE: This equipment has been tested and found to comply with the limits for a Class B digital device, pursuant to part of the FCC Rules. These limits are designed to provide reasonable protection against harmful interference in a residential installation. This equipment generates, uses, and can radiate radio frequency energy and, if not installed and used in accordance with the instruction manual, may cause harmful interference to radio communications. However there is no guarantee that the interference will not occur in a particular installation. If this equipment does cause harmful interference to radio and television reception, which can be determined by turning the equipment off and on, the user is encouraged to try to collect the interference by one or more of the following measures.

- Reorient or relocate the receiving antenna
- Increase the separation between the equipment and receiver
- Connect the equipment into an outlet on a circuit different from that to which the receiver is connected
- Consult the dealer or an experienced radio/TV technician for help
- FCC RADIATION EXPOSURE STATEMENT

This device complies with FCC radiation exposure limits set forth for an uncontrolled environment. This device should be installed and operated with minimum distance 20cm between the radiator & your body.

Section 4: Introduction to the EON ONE PRO System

Thank you for choosing the JBL EON ONE PRO system. The EON ONE PRO is a portable all-in-one linear-array system featuring rechargeable battery power, multiple input channels with individual tone controls, reverb, and Bluetooth® audio streaming. With a design that stores all the components into one lightweight unit for one-hand carry, the EON ONE PRO provides a versatile PA system that is perfect for situations where ease and portability are just as important as legendary JBL sound.

The following items are included in the EON ONE PRO package:

- 1 JBL EON ONE PRO base
- 2 listening height spacers
- 1 column speaker array
- 1 power cable
- Quick start guide

GETTING STARTED

1. Remove the EON ONE PRO system from the carton.
2. Push the latch lever and lift the cover, then remove the spacers and column speaker array from the back of the unit.

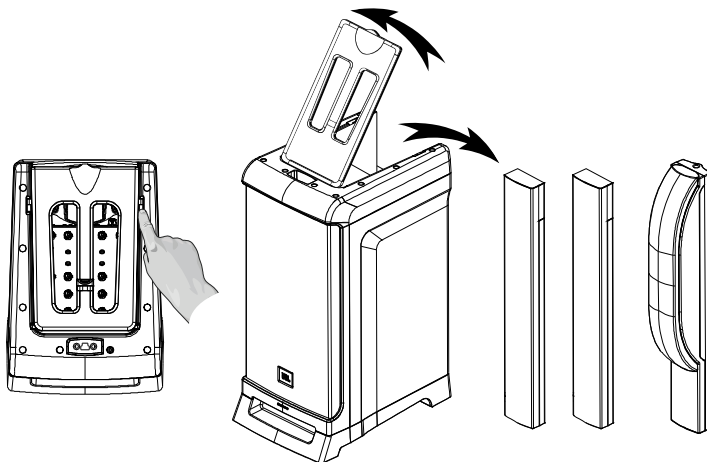

3. Place spacers for the desired listening level, then attach the column speaker array.

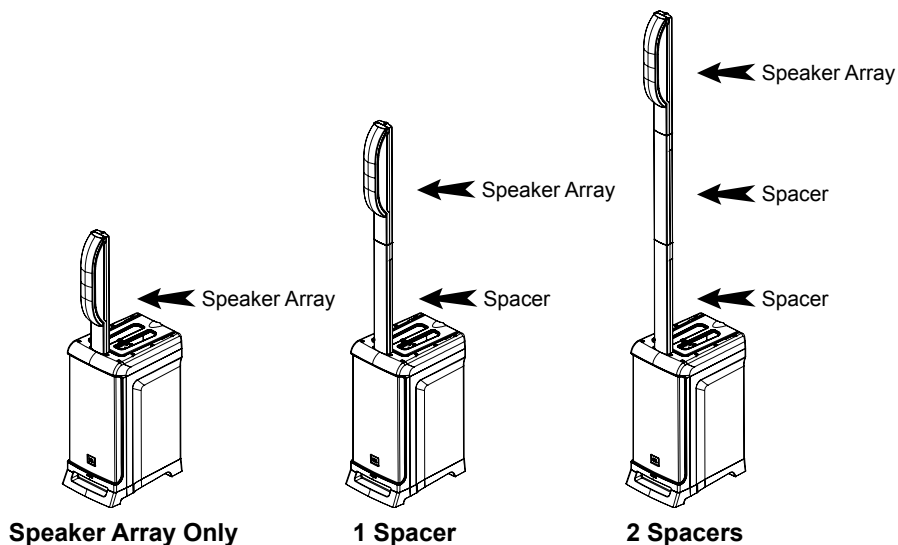

- Connect the female end of the power cable to the EON ONE PRO and plug the male end into a wall socket. Ensure the **Power** switch is turned off and the power LED is not lit. If using the unit's battery power feature, allow the unit to charge. The **Battery Level** meter will illuminate, indicating the unit is charging. The lithium-ion battery will take approximately 5 hours to fully charge, and the **Battery Level** meter will fully illuminate to indicate charging is complete.

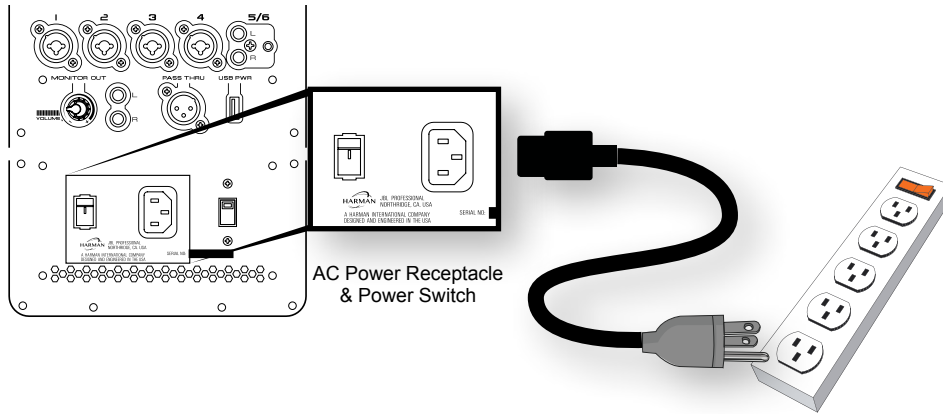

- Turn the **MASTER VOLUME** and **CHANNEL VOLUME** controls all the way to the left.

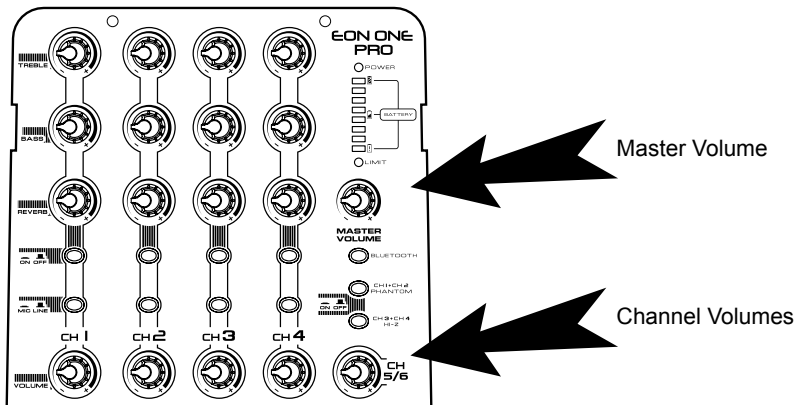

- Make audio connections. Set the **MIC/LINE** buttons for the type of connections being made to each mono channel (XLR = mic, 1/4" phone = line). If connecting instruments with pickups, connect them to inputs 3 and 4 and enable the **CH3+CH4 HI-Z** button. If using condenser mics, first connect them to inputs 1 and/or 2. Then enable the **CH1+CH2 PHANTOM** button. See "**Phantom Power Disclaimer**" on page 10 for important information about using phantom power.

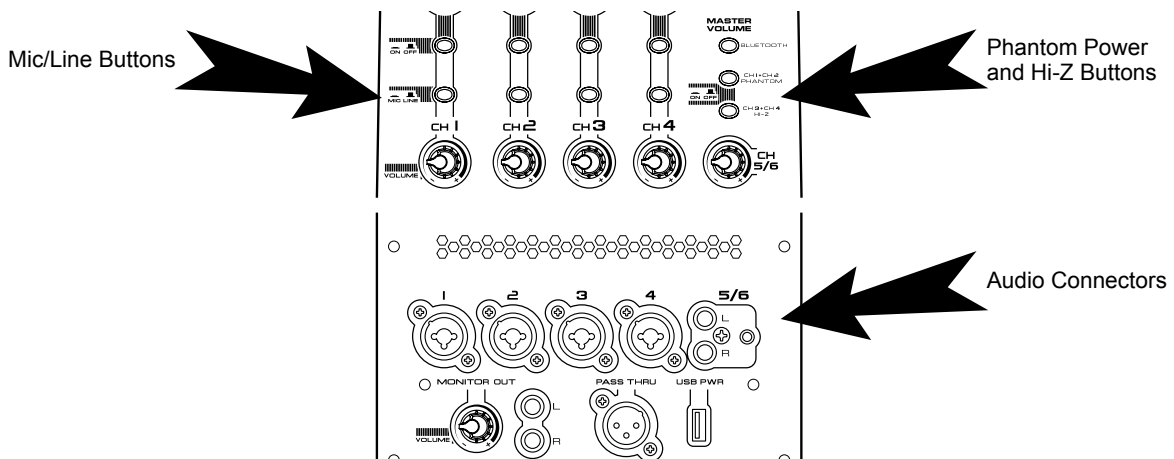

- Turn the **POWER** switch to the “on” position. The **POWER** LED indicators on the front and back of the unit will illuminate to indicate power is turned on.

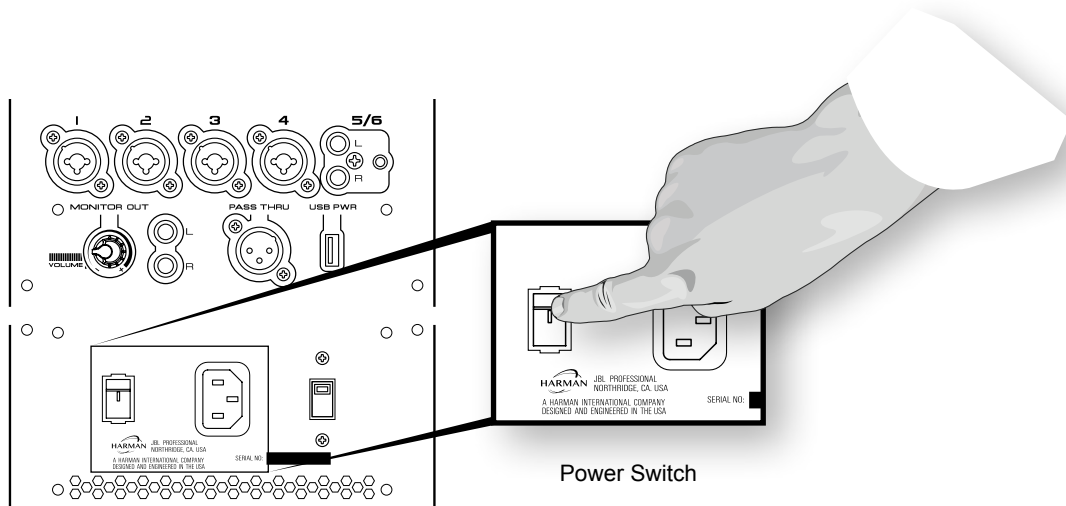

- If connecting a Bluetooth device for audio streaming, follow these steps:
 - Enable Bluetooth on your source device.
 - Press the **BLUETOOTH** button.
 - Find JBL EON ONE PRO on your device and select it.
 - If applicable, connect the device to the **USB POWER** port to keep it charged.

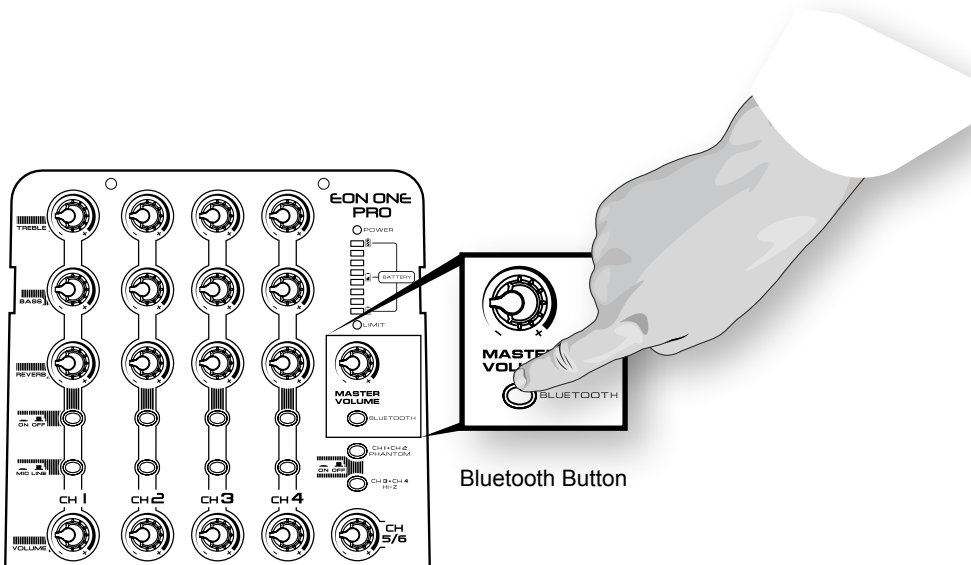

- Set the **Channel Volume** controls to 12 o'clock.
- Slowly turn the **Master Volume** control to the right until the desired volume is reached.
- Fine tune the **Channel Volume** controls for the desired mix balance. If using Bluetooth audio streaming, adjust the Bluetooth streaming device's volume control to balance it with the other channels.
- Add the finishing touches by adjusting the tone of each channel using the **TREBLE** and **BASS** controls. Enable and adjust the **REVERB** controls for any channels, such as vocals, which could use reverb.
- Enjoy your audio!

PA BASICS

A mixing board is actually a very simple device that takes the audio input signals (from the input channels) and "mixes" them to the outputs. The mixing board controls will typically enable the user to blend the input channel signal levels, affect their tone, and adjust each channel's reverb level. The signal is then fed from the mixing board to the amplifiers and on to the speakers. The EON ONE PRO is a self-contained PA system, which includes a mixing board, amplifiers, and speakers.

GETTING ACQUAINTED WITH THE EON ONE PRO POWERED MIXER

The powered mixer section of the EON ONE PRO system houses the mixing board and power amplifier. Here, all of the microphones, musical instruments, and external sound sources (such as MP3 players, CD players, or Bluetooth audio sources) can be connected.

The MONITOR OUT RCA jacks provide a "Front-of-House" feed, which can be connected to recording devices or additional speakers (such as a powered personal monitor or another PA system). The PASS THRU output can be used to connect multiple EON ONE PRO line arrays together for increased sound output.

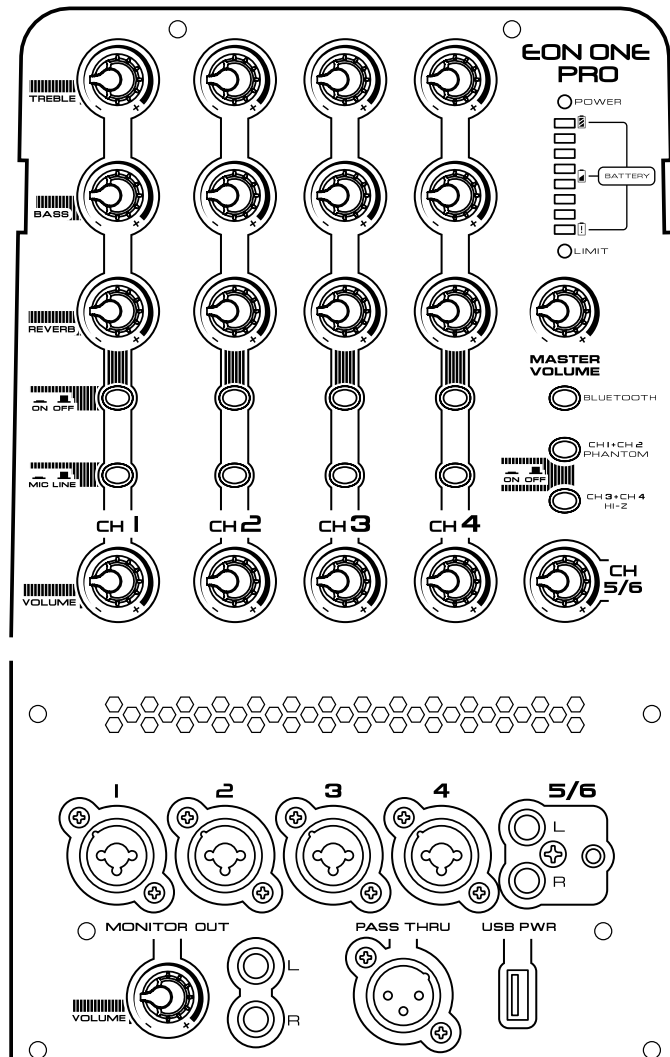

Let's take a look at the audio input channels first.

AUDIO INPUTS

The EON ONE PRO has 7 inputs: 4 mono inputs, a 2-channel (stereo) input, and a Bluetooth audio streaming input. All of the inputs will route to the speakers, the MONITOR OUT jack, and the PASS THRU out jack.

MONO MIC/LINE INPUTS

Moving from left to right there are four identical input strips comprised of (from top to bottom) a treble control, bass control, reverb control, reverb on/off button, mic/line selector, volume control, and a XLR / 1/4" combination input connector. On the right, there is a phantom power enable button for channels 1 and 2 and a hi-z button for inputs 3 and 4.

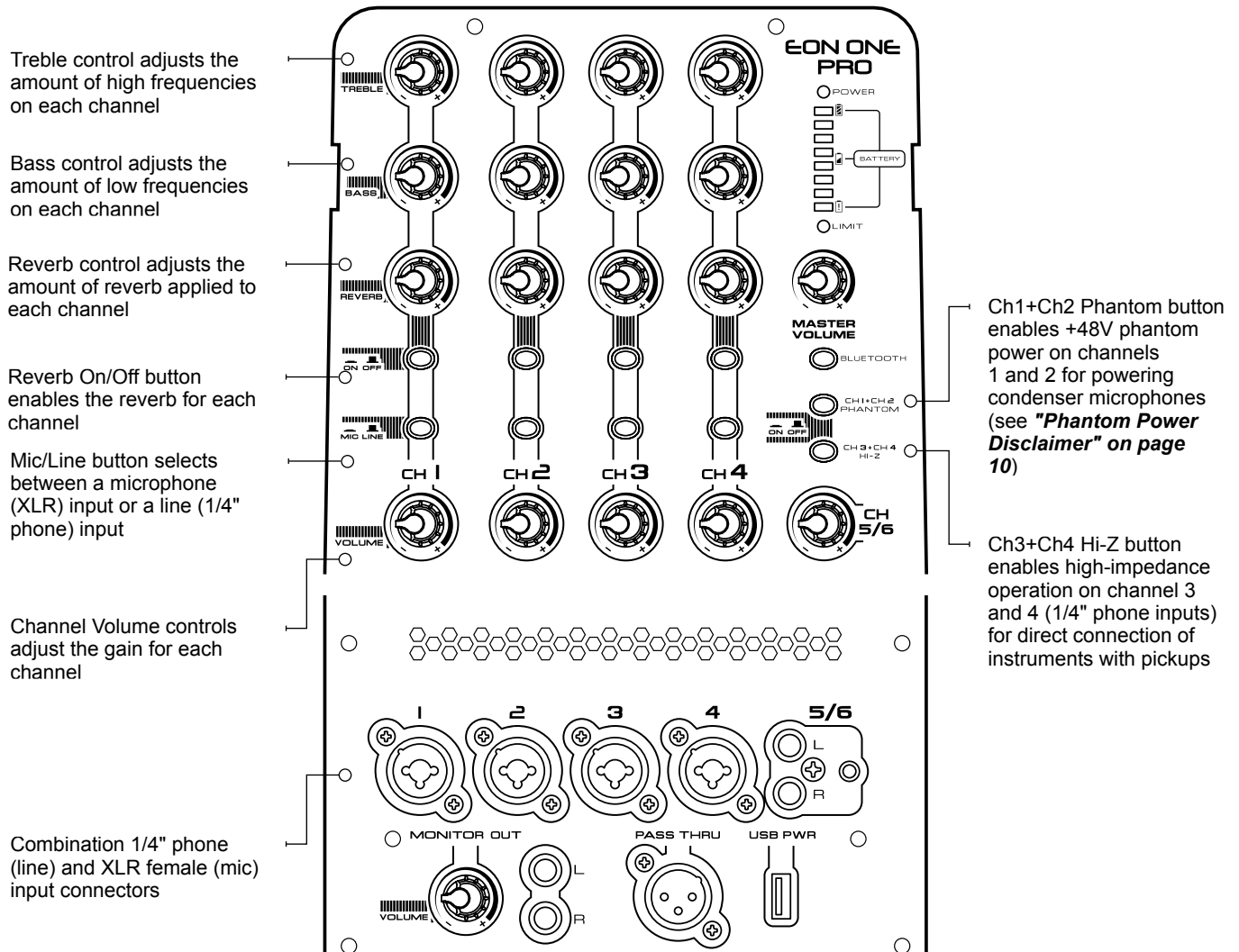

PHANTOM POWER DISCLAIMER

When using condenser microphones, +48V phantom power is required to be present at the contacts of the microphone (XLR) connector for the microphone to operate correctly. When phantom power is enabled, it is applied to both the CH1 and CH2 XLR inputs. Ensure that phantom power is off when not required.

To prevent damage to the EON ONE PRO or external devices when using condenser microphones, always turn down all EON ONE PRO output controls and ensure the +48V phantom power is off before connecting the microphone. Once the condenser microphone has been connected, enable the +48V phantom power, then raise the output controls to the desired levels.

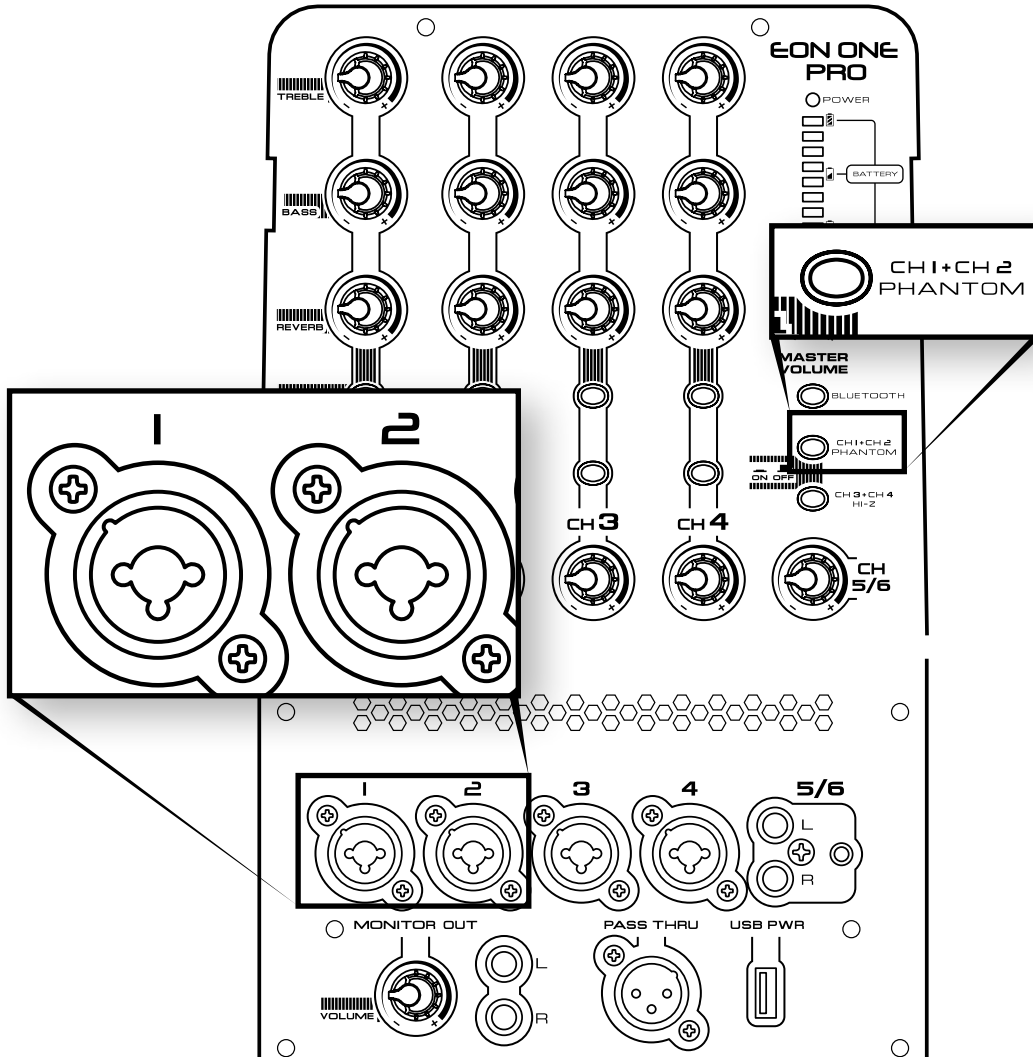

WARNING! Do not connect any unbalanced sources to the XLR inputs when +48V phantom power is enabled. Doing so may damage the connected device due to the phantom power voltage on pins 2 and 3 of the XLR connector.

STEREO INPUTS

The CH 5/6 stereo inputs are intended to be used primarily for MP3 or other personal music players and offer the option of using RCA plugs or a 3.5 mm stereo connector plug (the type typically found on personal music players). The CH 5/6 control is used to control volume for this stereo input.

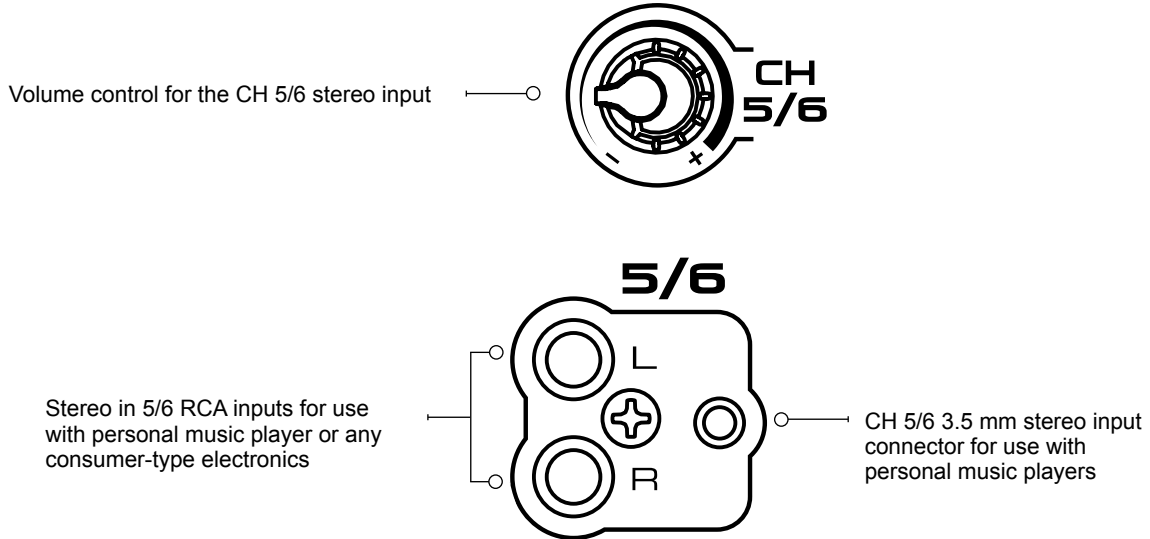

BLUETOOTH INPUT

The EON ONE PRO comes equipped with the ability to stream Bluetooth audio for music playback or backing tracks. To connect a Bluetooth device, first press the BLUETOOTH PAIR button on the back of the EON ONE PRO. Then select "EON ONE PRO" from the source device to complete the pairing. The level of the Bluetooth device relative to other source channels can be controlled from the Bluetooth device.

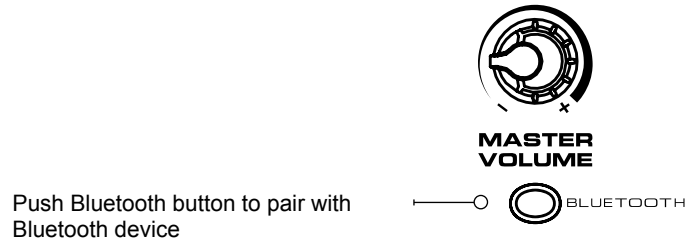

AUDIO OUTPUTS

Monitor Out connectors with volume control are used to route the stereo mixer signal to another destination, such as a recording device, powered personal monitor, or another PA system

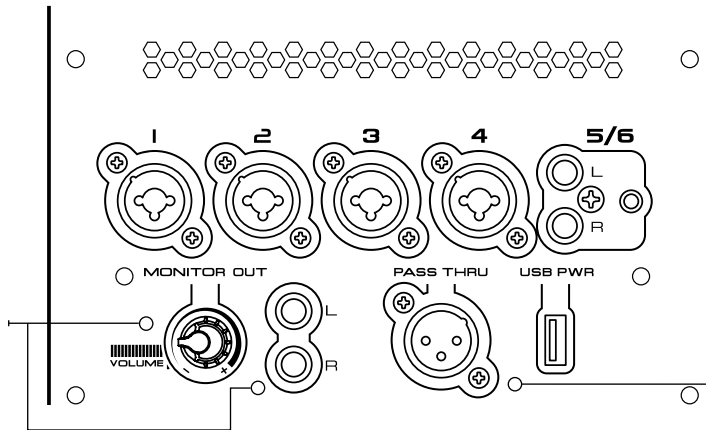

PASS THRU output can be connected to the XLR input of another JBL EON ONE PRO to expand the system for higher output capabilities

USB POWER PORT

This port can be used to charge a Bluetooth device or other portable music playback device during use.

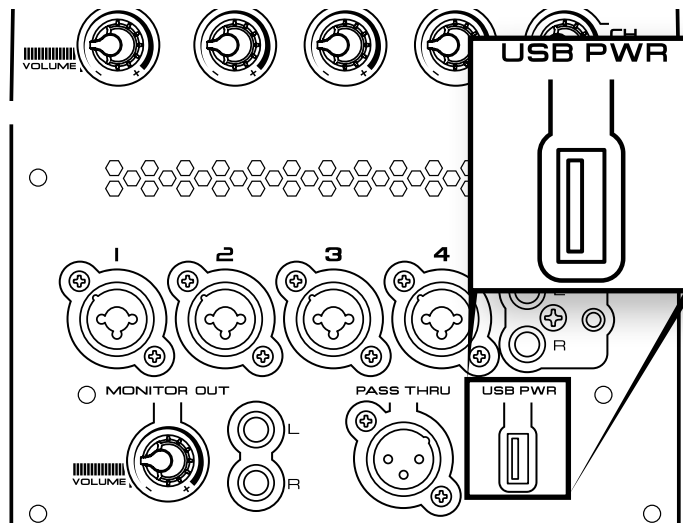

Section 5: Accessories

WHEELED BAG

The optional wheeled bag is available for effortless transport of an EON ONE PRO system. Visit jblpro.com or contact your local JBL Pro dealer for more information.

Section 6: System Specifications

System	System Type:	Battery-operated portable line array with powered mixer	
	Maximum SPL Output:	118 dB peak system output (pink noise)	
	Frequency Range (-10dB):	37.5Hz – 18.5kHz	
	Frequency Response (-3dB):	45Hz – 18kHz	
	AC input :	100 – 120 VAC, 50/60Hz; 220 – 240 VAC, 50/60Hz	
	USB Power Port:	Supplies 500mA	
Battery	Type:	Extended-life lithium-ion	
	Charge Time:	5 hours	
	Run Time:	Up to 6 hours	
Amplifier	Design:	Class D	
	System Power Rating:	250W LF/HF	
Mixer	Input Connectors:	6 inputs (4 x mono mic/line, 1 x stereo)	
	Channels:	1-4: XLR / 1/4" combo connectors (XLR = mic-level input, 1/4" = line-level input) (Enabling the CH3+CH4 HI-Z button switches 1/4" inputs on channels 3-4 to accept high-impedance signals from instruments.) 5-6: 3.5 mm stereo jack or stereo RCA connectors	
	Input Impedance:	Ch 1-4 combo XLR: 40 K Ohms balanced Ch 1-2 combo TRS: 40 K Ohms balanced Ch 3-4 combo TRS (CH3+CH4 HI-Z button disabled): 40 K Ohms balanced Ch 3-4 combo TRS (CH3+CH4 HI-Z button enabled): 40 K Ohms unbalanced Ch 5-6 RCA: 5 K Ohms unbalanced Ch 5-6 3.5 mm: 10 K Ohms unbalanced	
	Phantom Power:	48V (CH1-4 XLR inputs)	
	Bluetooth:	2-channel Bluetooth audio input streaming (stereo signal is fed to the MONITOR OUT jacks while mono-summed signal is fed to the line array speakers)	
	Output Connectors:	3 outputs (1 x stereo RCA monitor output, 1 x mono pass thru output)	
	Output Impedance:	RCA monitor outputs: 100 Ohms unbalanced XLR pass thru output: 37 Ohms balanced	
	Signal Indicators:	Limit: Yellow LED indicates limiter active condition	
	EQ:	Individual channel Bass and Treble controls, center detent, +/-12 dB cut and boost	
	System Limiter:	On-board DSP limiting and tuning	
	Speaker	LF Driver:	1 x 8" (203.2mm) woofer
		HF Driver:	6 x 2" (50.8mm) drivers
		Coverage Pattern:	80° x 60° (H x V)
		Enclosure:	Polypropylene
		Grille:	Powder-coated perforated steel
Dimensions (D x W x H)			
Unit Dimensions:		15.8" x 10.5" x 23.4" (401mm x 266mm x 594mm)	
Packaged Dimensions:	16.6" x 21.3" x 30.4" (421mm x 541mm x 772mm)		
Net Weight of System:	37.5 lbs (17.0 kg)		

Section 7: Cables & Connectors

XLR/F to XLR/M microphone cable	The standard cable for interconnection of microphone and line-level signals in professional audio systems. Example: Microphone to mixer.
TRS (balanced) 1/4" phone to XLR/M cable	For connecting balanced devices with 1/4" phone; may be used interchangeably.
TRS (unbalanced) 1/4" phone to XLR/M cable	For connecting instruments with unbalanced outputs to balanced XLR inputs.
TS (unbalanced) 1/4" phone to XLR/M cable	This cable is electrically identical to "TRS" (unbalanced) 1/4" phone and may be used interchangeably.
XLR/M to RCA (phono) cable	Connects consumer audio products and some DJ mixer outputs to professional audio equipment inputs.
TS (unbalanced) 1/4" phone to RCA (phono) cable	Connects an unbalanced 1/4" output to an RCA input.
TRS 1/4" phone to dual 1/4" phone cable	Splits a stereo output into separate left/right signals. Also used for connecting signal processors to mixer insert jacks.
XLR/F to XLR/M audio ground lift adapter	Used for breaking ground loops between interconnected devices — works with balanced inputs and outputs only.

XLR/F to XLR/M Microphone Cable

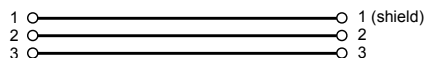

TRS (Balanced) 1/4" Phone to XLR/M Cable

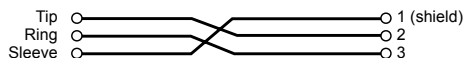

TRS (Unbalanced) 1/4" Phone to XLR/M Cable

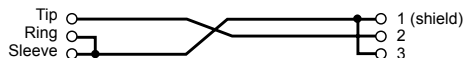

TS (Unbalanced) 1/4" Phone to XLR/M Cable

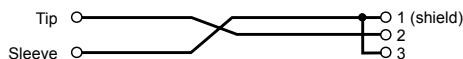

XLR/M to RCA (Phono) Cable

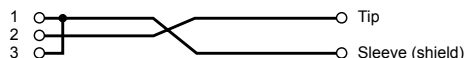

TS (Unbalanced) 1/4" Phone to RCA (Phono) Cable

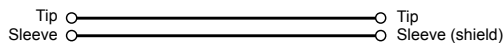

TRS 1/4" Phone to dual TS 1/4" Phone Cable

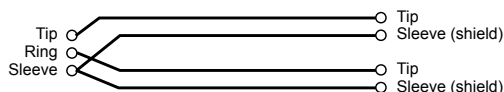
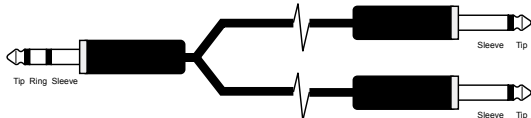

XLR/F to XLR/M Audio Ground Lift Adapter

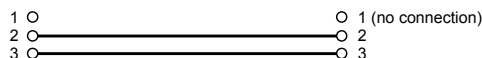
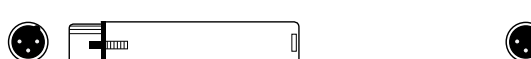

Section 8: Contact Information



Mailing Address:

JBL Professional
8500 Balboa Blvd.
Northridge, CA 91329

Shipping Address:

JBL Professional
8500 Balboa Blvd., Dock 15
Northridge, CA 91329

(Do not return product to this address without first obtaining prior authorization from JBL)

Customer Service:

Monday through Friday
8:00am - 5:00pm
Pacific Coast Time in the U.S.A.
(800) 8JBLPRO (800.852.5776)
www.jblproservice.com

On The World Wide Web:

www.jblpro.com

Professional Contacts, Outside the USA:

Contact the JBL Professional Distributor in your area. A complete list of JBL Professional international distributors is provided at our U.S.A. website: www.jblpro.com

Product Registration:

Register your product online at www.jblpro.com

Section 9: Warranty Information

The JBL Limited Warranty on professional loudspeaker products (except for enclosures) remains in effect for five years from the date of the first consumer purchase. JBL amplifiers are warranted for three years from the date of original purchase. Enclosures and all other JBL products are warranted for two years from the date of original purchase.

Who Is Protected By This Warranty?

Your JBL Warranty protects the original owner and all subsequent owners so long as: A.) Your JBL product has been purchased in the Continental United States, Hawaii or Alaska. (This Warranty does not apply to JBL products purchased elsewhere except for purchases by military outlets. Other purchasers should contact the local JBL distributor for warranty information.); and B.) The original dated bill of sale is presented whenever warranty service is required.

What Does The JBL Warranty Cover?

Except as specified below, your JBL Warranty covers all defects in material and workmanship. The following are not covered: Damage caused by accident, misuse, abuse, product modification or neglect; damage occurring during shipment; damage resulting from failure to follow instructions contained in your Instruction Manual; damage resulting from the performance of repairs by someone not authorized by JBL; claims based upon any misrepresentations by the seller; any JBL product on which the serial number has been defaced, modified or removed.

Who Pays For What?

JBL will pay all labor and material expenses for all repairs covered by this warranty. Please be sure to save the original shipping cartons because a charge will be made if replacement cartons are requested. Payment of shipping charges is discussed in the next section of this warranty.

How To Obtain Warranty Performance

If your JBL product ever needs service, write or telephone us at JBL Incorporated (Attn: Customer Service Department), 8500 Balboa Boulevard, PO. Box 2200, Northridge, California 91329 (818-893-8411). We may direct you to an authorized JBL Service Agency or ask you to send your unit to the factory for repair. Either way, you'll need to present the original bill of sale to establish the date of purchase. Please do not ship your JBL product to the factory without prior authorization. If transportation of your JBL product presents any unusual difficulties, please advise us and we may make special arrangements with you. Otherwise, you are responsible for transporting your product for repair or arranging for its transportation and for payment of any initial shipping charges. However, we will pay the return shipping charges if repairs are covered by the warranty.

Limitation of Implied Warranties

ALL IMPLIED WARRANTIES, INCLUDING WARRANTIES OF MERCHANTABILITY AND FITNESS FOR PARTICULAR PURPOSE, ARE LIMITED IN DURATION TO THE LENGTH OF THIS WARRANTY.

EXCLUSION OF CERTAIN DAMAGES

JBL'S LIABILITY IS LIMITED TO THE REPAIR OR REPLACEMENT, AT OUR OPTION, OF ANY DEFECTIVE PRODUCT AND SHALL NOT INCLUDE INCIDENTAL OR CONSEQUENTIAL DAMAGES OF ANY KIND. SOME STATES DO NOT ALLOW LIMITATIONS ON HOW LONG AN IMPLIED WARRANTY LASTS AND/OR DO NOT ALLOW THE EXCLUSION OF INCIDENTAL OR CONSEQUENTIAL DAMAGES, SO THE ABOVE LIMITATIONS AND EXCLUSIONS MAY NOT APPLY TO YOU. THIS WARRANTY GIVES YOU SPECIFIC LEGAL RIGHTS, AND YOU MAY ALSO HAVE OTHER RIGHTS, WHICH VARY, FROM STATE TO STATE.



Rev C